

Leonardo

UK

CY

ES

PT

LV

EE

RO

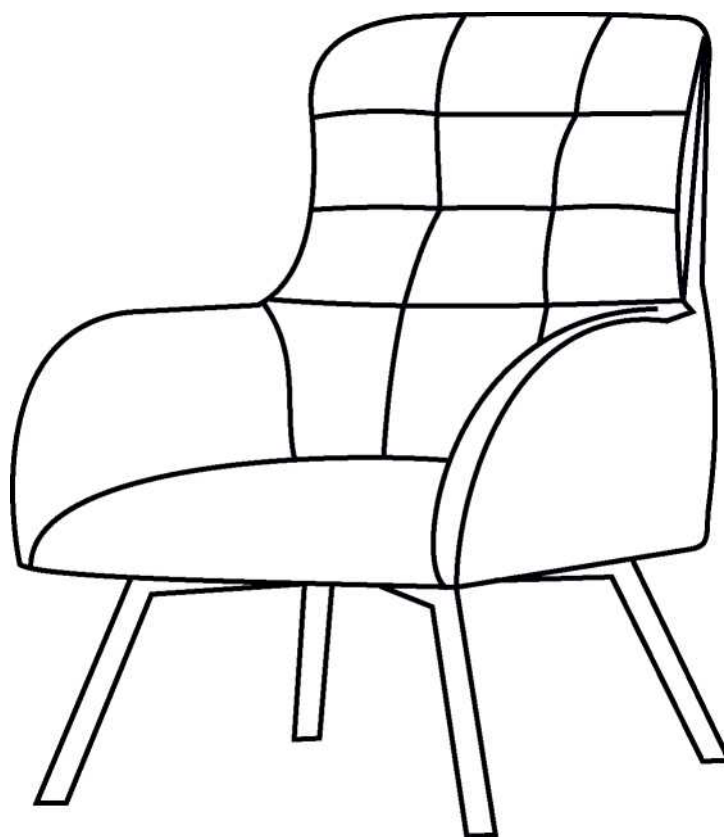



Sleep.8

Before assembly:

1. Check the appearance and integrity of the parts in the package. Claims for damage are accepted only for products without traces of assembly.
2. Save the packaging until the end of assembly. If during the assembly a defect and incompleteness of the product is detected, it is necessary to keep the packaging until the representative of the trading company visits you.
3. Check the number of parts and accessories according to the packing list and sort the accessories into groups. The manufacturer reserves the right to make structural changes to the product, replace fittings and hardware with similar parts that do not worsen the appearance and do not affect the functional properties of the product.
4. Follow the assembly order given in this manual. If the instructions for assembly and operation are not followed, the manufacturer's warranty obligations are removed. The assembly and operating instructions must be kept for the entire period of use of the product.
5. Move all parts carefully, without pushing them; stack them safely; avoid dropping and hitting them. Assemble the product on a flat surface.

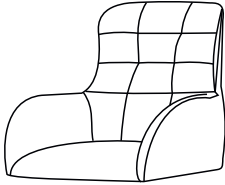
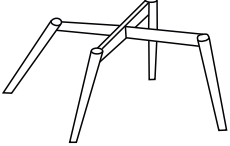
PACKING LIST FOR LEONARDO ARMCHAIR

			
1 pc	1 pc	4 pc	1 pc

ASSEMBLY GUIDELINES

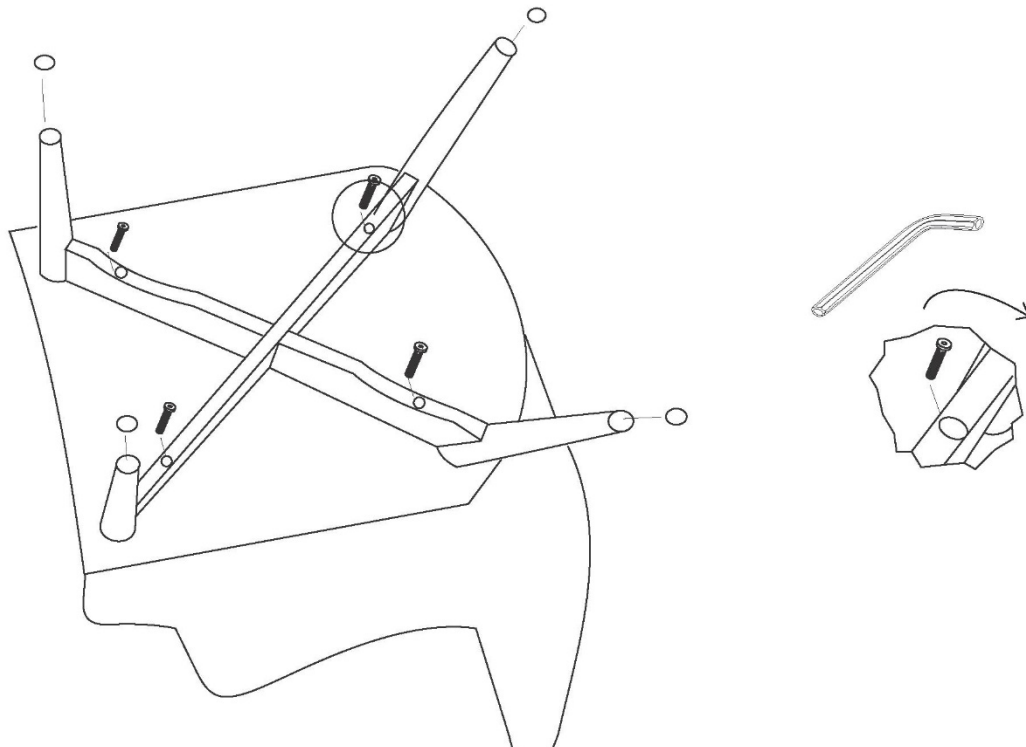

(The back legs are supposed to be shorter)



Πριν από τη συναρμολόγηση:

- Έλέγξτε την εμφάνιση και την ακεραιότητα των εξαρτημάτων στη συσκευασία. Οι αξιώσεις για τη ζημία τους γίνονται αποδεκτές **μόν**ο για προϊόντα χωρίς ίχνη συναρμολόγησης.
2. Αποθηκεύστε τη συσκευασία μέχρι το τέλος της συναρμολόγησης! Εάν εντοπιστούν ελαττώματα και ατέλειες του προϊόντος κατά τη διάρκεια της διαδικασίας συναρμολόγησης, είναι απαραίτητο να διατηρήσετε τη συσκευασία μέχρι να σας επισκεφτεί ο εκπρόσωπος εμπορικής εταιρείας.
3. Ελέγξτε τον αριθμό των εξαρτημάτων και των εξαρτημάτων σύμφωνα με τη λίστα της πλήρους λίστας, διαιρέστε τα εξαρτήματα σε ομάδες. Ο κατασκευαστής διατηρεί το δικαίωμα να κάνει αλλαγές στο σχεδιασμό του προϊόντος, να αντικαταστήσει εξαρτήματα και υλικό με παρόμοια που δεν βλάπτουν την εμφάνιση και δεν επηρεάζουν τις λειτουργικές ιδιότητες του προϊόντος.
4. Ακολουθήστε τη διαδικασία συναρμολόγησης που δίνεται σε αυτό το εγχειρίδιο! Εάν δεν τηρηθούν οι οδηγίες συναρμολόγησης και λειτουργίας, καταργούνται οι υποχρεώσεις εγγύησης του κατασκευαστή. Οι οδηγίες συναρμολόγησης και λειτουργίας πρέπει να φυλάσσονται για ολόκληρη την περίοδο λειτουργίας του προϊόντος.
5. Μετακινήστε όλα τα μέρη προσεκτικά, χωρίς τραντάγματα, στοίβα σταθερά, αποφύγετε τις πτώσεις και τα χτυπήματα τους! Η συναρμολόγηση του προϊόντος πρέπει να πραγματοποιείται σε επίπεδη επιφάνεια.

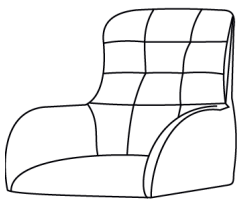
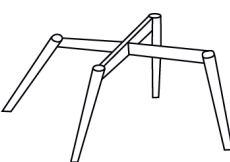
Τοποθέτηση λίστας της πολυθρόνα Leonardo/Λεονάρντο

			
1 τεμ.	1 τεμ.	4 τεμ.	1 τεμ.

Οδηγίες συναρμολόγησης

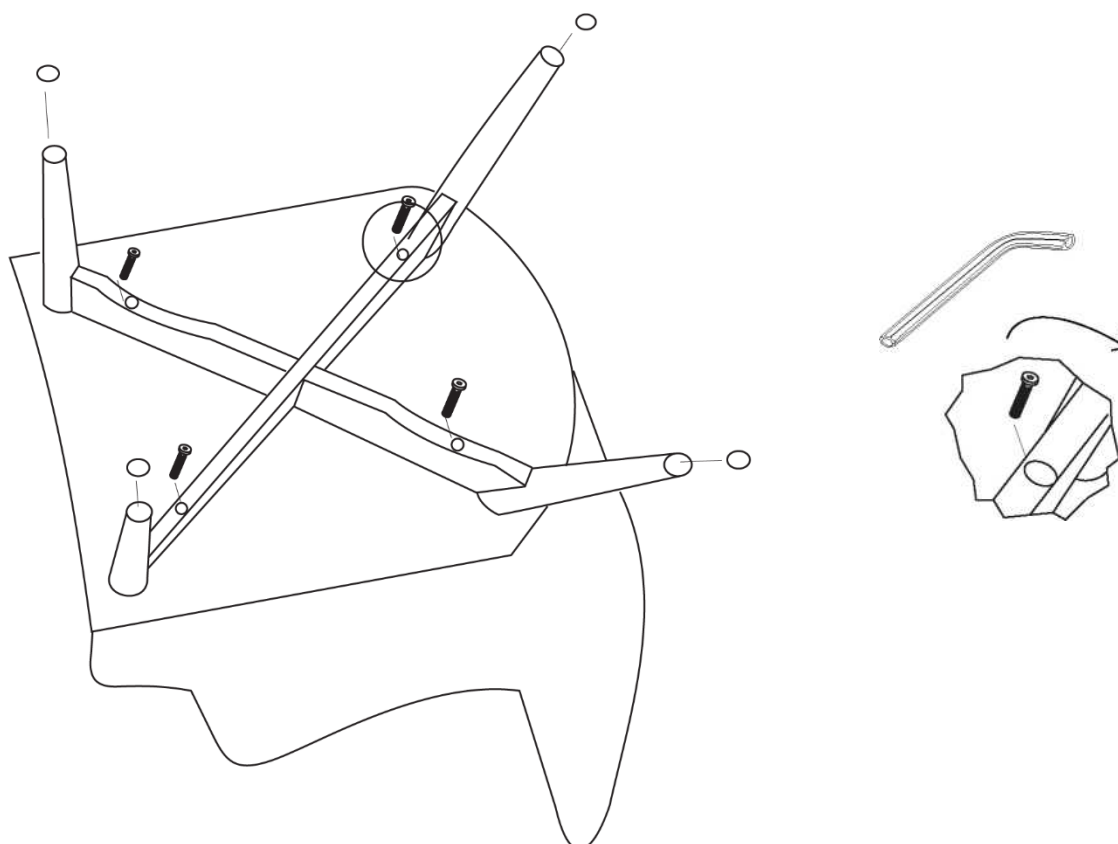



Τα πίσω πόδια της δομής πρέπει να είναι μικρότερα.

Antes del montaje:

1. **¡Compruebe el aspecto y la integridad de las piezas de la caja!** Las reclamaciones por daños solo se aceptan si los productos NO tienen rastros de montaje visibles.
2. **¡No deseché el embalaje y este manual hasta que se complete el montaje!** En caso de detección en el proceso de montaje de piezas defectuosas y no conformidad del producto, es necesario conservar el embalaje hasta que se visite al representante de la empresa comercial.
3. **Compare las piezas y los accesorios con la lista antes de comenzar el montaje.** El fabricante se reserva el derecho de realizar cambios en el diseño del producto, reemplazar accesorios y hardware, reemplazar con análogos, que no alteren las propiedades funcionales del producto.
4. **¡Observe el orden de montaje especificado en las instrucciones!** En caso de incumplimiento de las instrucciones de montaje y funcionamiento, el fabricante renuncia a todas las obligaciones de la garantía. Las instrucciones de montaje y funcionamiento deben conservarse durante todo el período de uso del producto.
5. ¡Mueva todas las piezas con cuidado, sin golpes, colóquelas de forma segura, ¡no se caigan ni golpeen! El producto debe colocarse sobre una superficie plana.

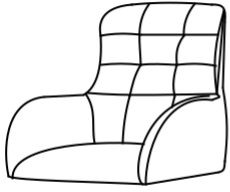
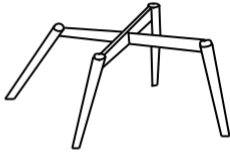
Lista de módulos de la silla Leonardo

			
1	1	4	1

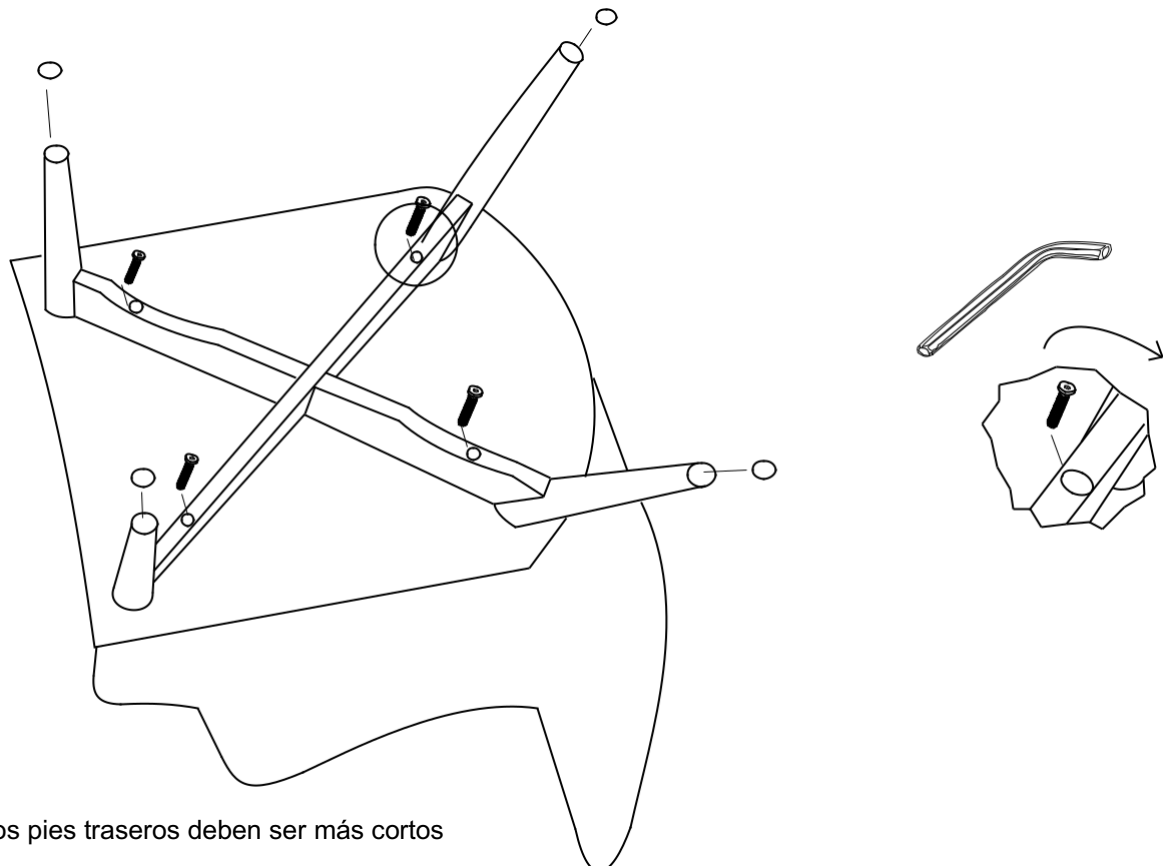

Instrucciones de montaje



Antes da montagem:

- 1) Verifique a aparência e a integridade das peças na caixa! As reivindicações em relação ao danos são aceites somente se os produtos NÃO tenham traços visíveis de montagem.
- 2) Não descarte a embalagem até que a montagem seja concluída! No caso da detecção no processo de montagem de peças defeituosas e-não de do produto, é necessário manter a embalagem até que o representante da empresa de vendas seja visitado.
- 3) Confira as peças e os acessórios contra a lista antes de iniciar a montagem. O fabricante reserva-se o direito de fazer mudanças no desenho do produto, substituir acessórios e ferragens substituir com os análogos, que não alteram as propriedades funcionais do produto.
- 4) Observe a ordem de montagem especificado nas instruções! A não conformidade com as instruções de montagem e operação, o fabricante se isenta de todas as obrigações de garantia. As instruções de montagem e operação devem ser mantidas durante todo o período de uso do produto.
- 5) Mova todas as peças com cuidado, sem solavancos, coloque as com segurança, não deixe cair e nem bata! Efetue a montagem do produto em uma superfície plana.

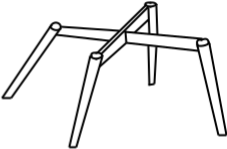
Lista de módulos de cadeira Leonardo

			
1	1	4	1

Instruções de montagem

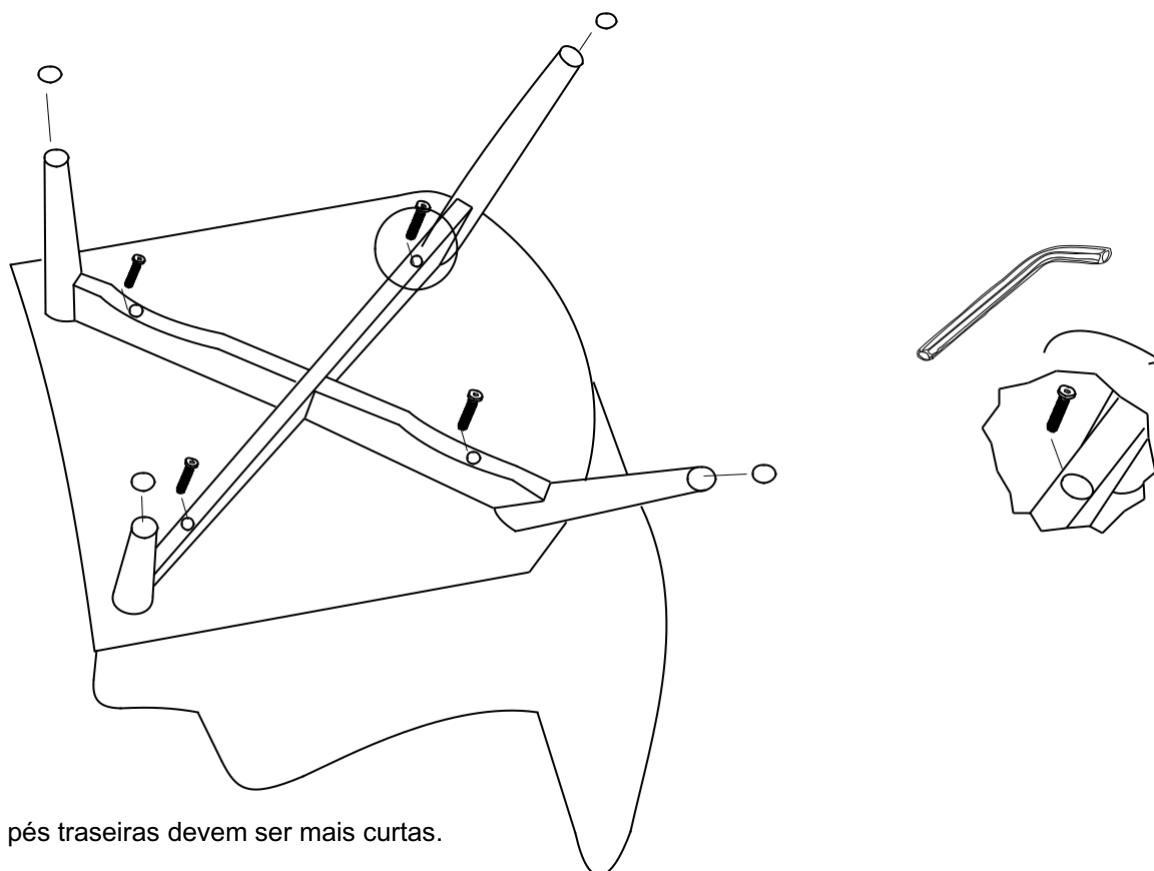



*Os pés traseiras devem ser mais curtas.

Pirms montāžas:

1. Pārbaudiet iepakojumā esošo detaļu izskatu un integritāti. Pretenzijas par to bojājumiem tiek pieņemtas tikai attiecībā uz izstrādājumiem bez montāžas pēdām.
2. Saglabāiet iepakojumu līdz montāžas beigām! Ja montāžas procesā tiek konstatēts preces defekts un nepilnība, iepakojums ir jā saglabā līdz tirdzniecības uzņēmuma pārstāvja atbraukšanai pie Jums.
3. Detaļu un furnitūras daudzumu pārbaudiet saskaņā ar komplektējošo sarakstu, sadaliet furnitūru grupās. Ražotāju uzņēmums patur tiesības veikt izstrādājuma konstrukcijas izmaiņas, nomainīt furnitūru un aparatūru pret līdzīgām, kas nepasliktina izskatu un neietekmē izstrādājuma funkcionālās īpašības.
4. Ievērojiet šajā instrukcijā norādīto montāžas secību! Ja netiek ievērota montāžas un lietošanas instrukcija, no ražotāju uzņēmuma tiek noņemtas garantijas saistības. Montāžas un lietošanas instrukcijas jā saglabā visu izstrādājuma lietošanas laiku.
5. Pārvirojiet visas detaļas uzmanīgi, bez raustišanas, salieciet tās stabili, izvairieties no to krišanas un triecieniem! Izstrādājuma montāžu veiciet uz līdzenas virsmas.

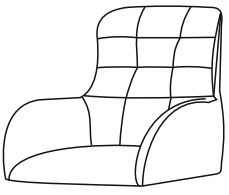
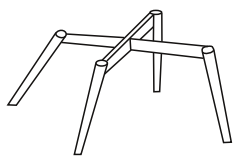
Krēsla Leonardo komplektējošo saraksts

			
1 gab.	1 gab.	4 gab.	1 gab.

Montāžas instrukcija

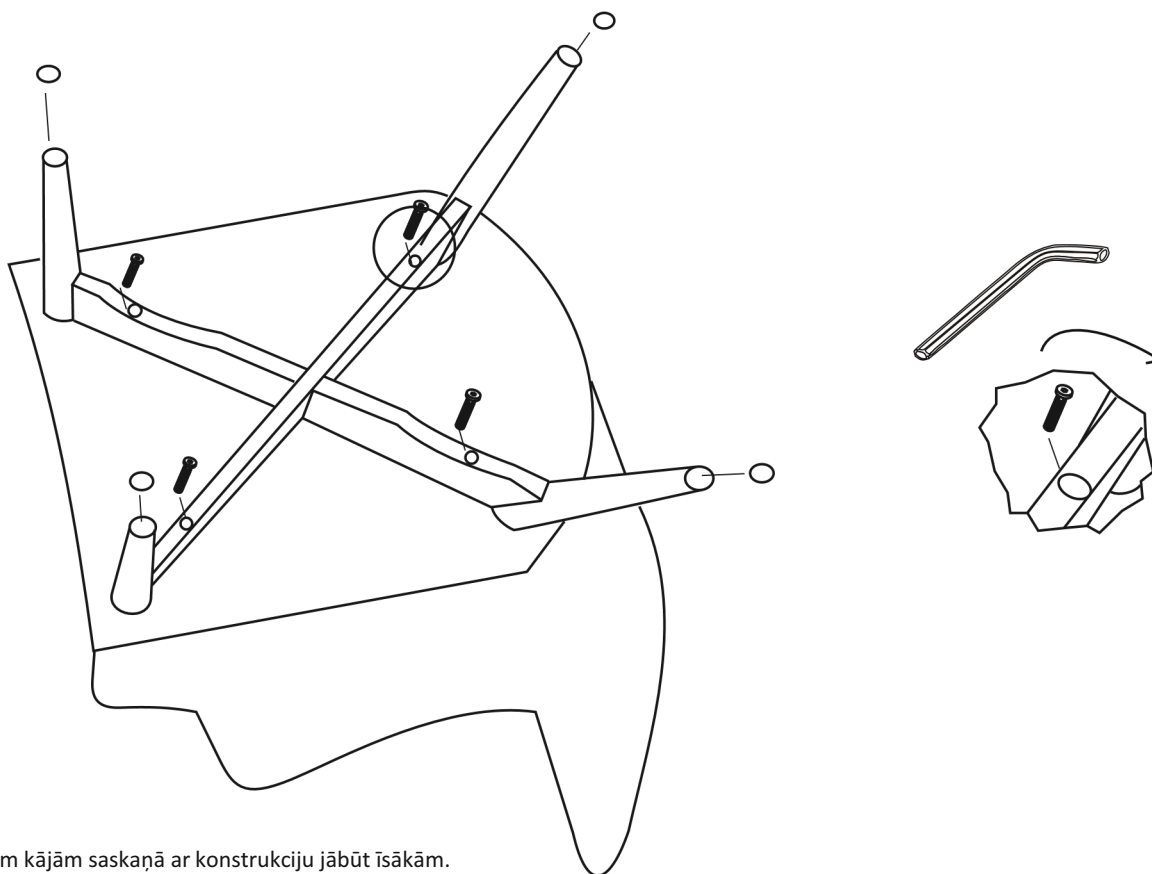



Aizmugurējām kājām saskaņā ar konstrukciju jābūt īsākām.

Enne kokkupanekut:

1. Kontrollige pakendis olevate detailide välimust ja terviklikkust. Pretensioone nende kahjustuste kohta aktsepteeritakse ainult kokkupanemisjälgedeta toodete puhul.
2. Hoidke pakend alles kokkupaneku lõpuni! Kui avastate kokkupaneku käigus tootel praaki ja mittekomplektsuse, peate pakendit alles hoidma kuni kaubandusettevõtte esindaja teie juurde saabumiseni.
3. Kontrollige detailide ja liitmike arvu vastavalt komplekteerimisnimekirja loendile, sorteerige liitmikud rühmade kaupa. Tootjaettevõtte jätab endale õiguse teha tootes konstruktsioonilisi muudatusi, asendada liitmikud ja peenraud sarnaste vastu, mis ei halvenda välimust ega mõjuta toote funktsionaalseid omadusi.
4. Järgige käesolevas juhendis antud kokkupaneku järjekorda! Kokkupanemise ja kasutusjuhendi mittejärgmine tühistab tootjapoolse garantii. Kokkupaneku ja kasutusjuhend tuleb säilitada kogu toote eluea jooksul.
5. Liigutage kõiki detaile ettevaatlikult, ilma tõmblemiseta, asetage kindlalt, vältige nende kukkumisi ja lööke! Paigaldage toode tasasele pinnale.

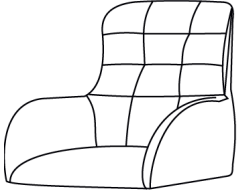
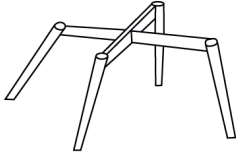
Leonardo tugitooli kompleksus

			
1 tk	1 tk	4 tk	1 tk

Kokkupanemise juhend

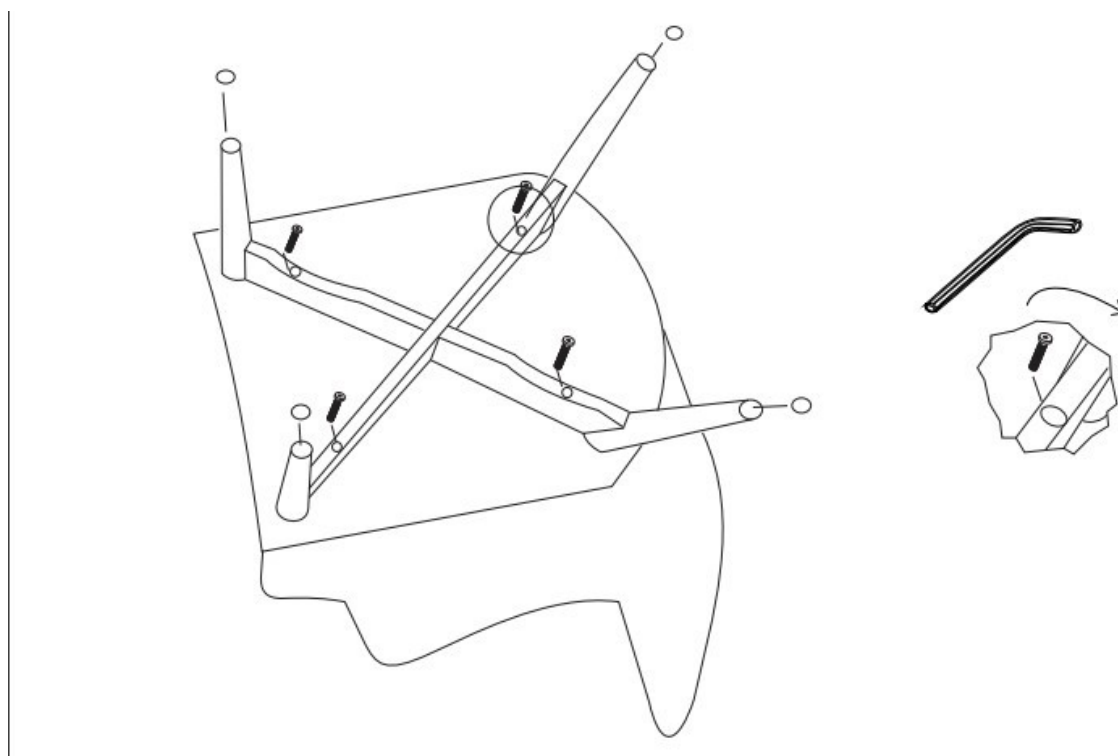



* Tagajalad peavad olema konstruktsiooni kohaselt lühemad.

Înainte de asamblare:

1. Verificați aspectul și întregimea detaliilor din ambalaj. Plângerile privind deteriorarea acestora se primesc numai pentru produsele care nu au urme de asamblare.
2. Păstrați ambalajul până la finalul asamblării! În cazul în care în procesul de asamblare se dovedește un defect sau caracterul incomplet al setului de asamblare trebuie să păstrați ambalajul până în momentul sosirii la Dumneavoastră al unui reprezentant al companiei.
3. Verificați cantitatea detaliilor și al materialelor accesorii cu ajutorul borderoului de expediere, divizați materialele accesorii în grupuri. Producătorul își rezervă dreptul de a introduce schimbări constructive ale produsului, de a preschimba detaliile accesorii și elementele de fixare cu altele analogice care nu strică aspectul produsului și nu daunează caracteristicilor funcționale ale acestuia.
4. Respectați ordinea de asamblare propusă în aceste instrucțiuni! În caz de nerespectare a instrucțiunilor de asamblare și de utilizare, obligațiile de garanție din partea producătorului se anulează. Instrucțiunile de asamblare și de utilizare trebuie păstrate pe toată durata de utilizare a produsului.
5. Mutați toate detaliile cu grijă, fără a le smuci, așezați-le în poziții fixe, evitați să le scăpați sau să le loviți! Asamblarea produsului trebuie să se desfășoare pe o suprafață netedă.

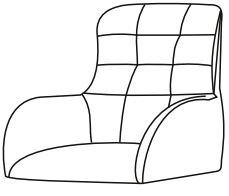
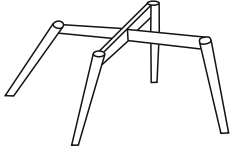
Borderou de expediție al fotoliului Leonardo

			
1 buc.	1 buc.	4 buc.	1 buc.

Instrucțiuni de asamblare

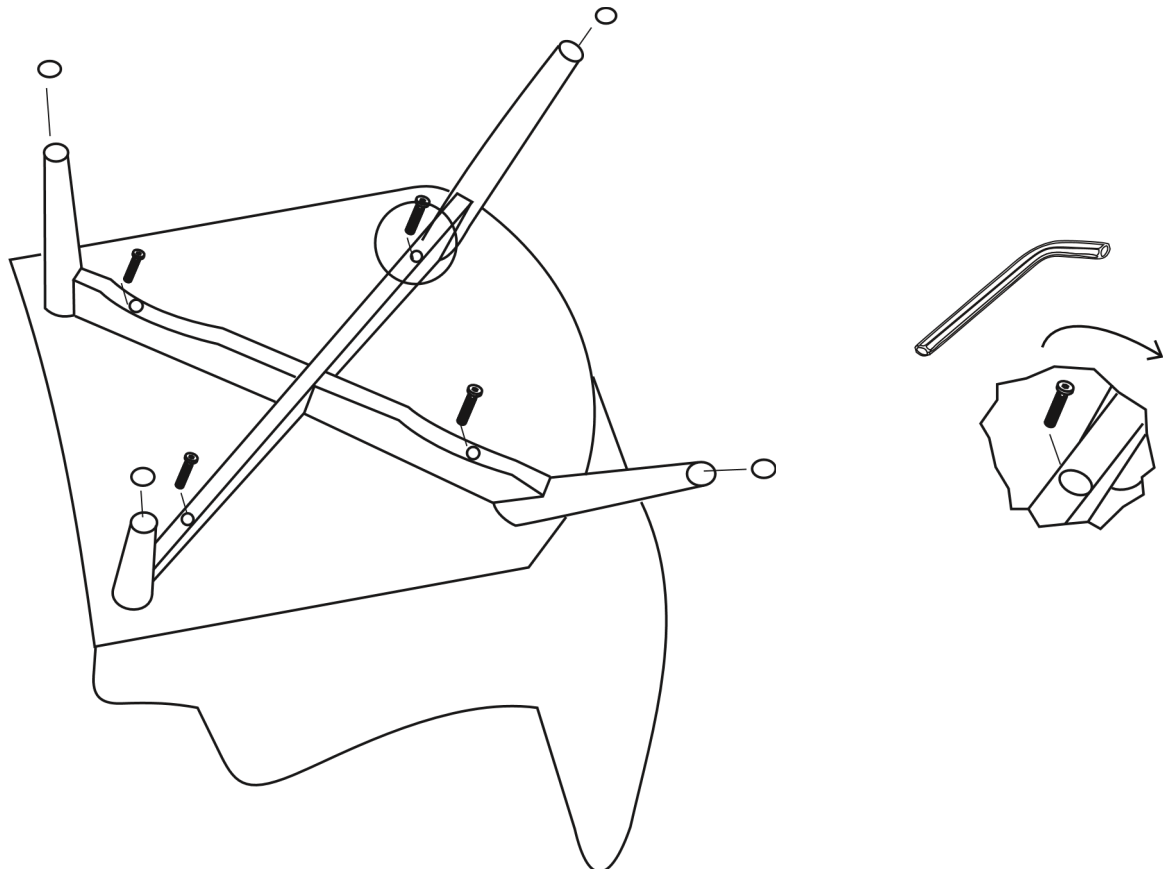

Conform designului picioarele din spate trebuie să fie mai scurte

The period during which household furniture is in good condition and retains a presentable appearance depends on the conditions of use.

By adhering to the simple rules described below, you will be able to keep all the parts of your furniture in the best possible condition.

1. USE THE FURNITURE ONLY FOR THE INTENDED PURPOSE

- The chair is designed for one person.

2. PERMISSIBLE LOADS

- The furniture must only be used for its intended purpose.
- The maximum evenly distributed load on the folded/ unfolded chair or chair-bed is 100 kg.

3. GETTING READY FOR USE

- After storage and transportation at temperatures below +5°C, the furniture must be kept at room temperature before use.
- Bear in mind that it is better to entrust the assembly process to professionals. If you assemble the furniture yourself, make sure to read the assembly guidelines included in the package and follow them at all points.
- Sealed packaging protects the furniture from external factors (getting dirty) and preserves the production smell of a new product (as with any new item). After removing the packaging and assembling the furniture, it is necessary to air it for at least 1 week.

4. CONDITIONS FOR STORAGE AND USE

- You can store furniture in closed warehouses at a temperature of +2°C and a humidity level of 45% to 70%.
- During transportation, storage and use, avoid the contact of the furniture (including furniture elements that come into contact with the floor) with water and other liquids.
- The furniture is intended for use only in closed, heated rooms at temperatures from +15°C to +25°C with an optimum air humidity of 45%-70%. Furniture sets that have been used outdoors or in abnormal temperature conditions are not covered by the warranty.
- Place furniture on a flat, hard floor.
- Prolonged exposure to direct sunlight on furniture may cause fading. In the case of replacement and / or addition of sections, these sections may differ in color.
- Heating parts of furniture over 40 °C is not allowed.
- Do not place hot objects on furniture surfaces.
- The structural elements of the furniture are not designed for extreme loads: pressure, strong frontal impacts, etc.
- Packing and location of furniture during storage and operation should not create pressure that can lead to deformation of soft furniture elements. Use furniture on a solid, flat, level surface against a wall or other vertical support.
- Furniture should be installed at least 50-70 cm away from heaters and protected from heat.

5. FURNITURE CARE AND CLEANING

- To remove dust from surfaces use a dry soft cloth (flannel, calico). It is not allowed to use soda, washing powders, abrasive pastes and other products that are not intended for furniture care.
- It is recommended from time to time (once every six months) to check the tightening of bolted and screw connections and, if necessary, tighten them.

- Protect furniture from stains and dirt. Remove the resulting stain as quickly as possible before drying, by blotting it with a clean, dry cloth. If necessary, moisten with a mild soap solution or upholstery cleaner. Remove any remaining water from the furniture surface immediately with a soft cloth. Before cleaning, test the selected product on a sample of the upholstery fabric included in the documentation kit, or on a small, inconspicuous area of the fabric on the product.
- Do not iron pile fabrics, use only brushes with soft bristles to comb the pile.
- Stubborn dirt should be removed with special cleaners. Follow the cleaner manufacturer's instructions for how and where to use them.
- Do not use aggressive liquids (acids, alkalis, oils, solvents, etc.). Such substances are active reagents: interaction with them leads to negative consequences for furniture.
- Do not use hard tools for cleaning (scrapers, sponges with a working coating of plastic or metal fibre material)!

6. SAFETY PRECAUTIONS

- Install and use furniture on a level surface. This will avoid falling and deformation.
- Never use furniture for other purposes, or exceed the permissible load on shelves and drawers.
- Never stand up, jump, walk on furniture, climb and sit on shelves, drawers, hang on doors and bars. This rule applies to both adults and children.
- Never place hot, damp, dirty things and objects with sharp and cutting edges on the surface of the furniture. Never throw objects on furniture, especially on glass surfaces.
- Never pull, drag and move furniture when loaded.
- Never pull, move and turn over the sofa, chair-bed, chair by the armrests, holding on to the drawers and soft elements.
- **ATTENTION!** Contact between the surface of furniture and naked skin can adversely affect the appearance of eco-leather or furniture fabric due to natural skin exudates.

7. WARRANTY

Conditions for granting a manufacturer's warranty for the goods:

- the requirements for the operation and maintenance of furniture, assembly instructions are followed.
- No mechanical damage, traces of self-repair.
- Furniture is used for its intended purpose, not used for commercial purposes without permission for commercial use.
- The packaging of the goods is preserved until the end of the assembly or the moment of detecting any damage to the furniture, missing parts or accessories. The damaged part must not show traces of assembly. These measures are necessary to determine the cause of the defect.

If the following is kept in place:

- Marking labels of the manufacturer on the furniture.
- Documents confirming the purchase of furniture (retail contract of sale).

The following are not considered as manufacturing defects:

- Changes in product parts, as well as technologies that were used by the manufacturer to improve the product, but did not affect the consumer properties of the product.
- Damage to the fabric upholstery of the goods: scratches, cuts, snags, stains and dirt, traces of cleaning, seam breaks, decorative stitching that occurred after the acceptance and / or assembly of the goods.
- Minor differences in shades within two points, texture of upholstery materials in the furniture set. The difference in the tint of the fabric on one product in different planes under different angles of view and lighting.

- The occurrence of pellets on the upholstery fabric, lint jamming on chenille and velour, abrasions, as well as the loss of the appearance of the furniture fabric and the shedding of the top layer of eco-leather

after cleaning the furniture surface with water or other means that are not in accordance with the signs for caring for it.

- Slight creases on the facing material of the soft elements that occur after the removal of loads.
- Deviation in the parallelism of decorative stitches within one piece of furniture or in a set of furniture.
- The smell of a new product within two points (see preparation for use).

8. DISPOSAL

- The furniture does not contain substances hazardous to humans and the environment. At the end of its service life, it can be disposed of as household waste.